

ROSEN



R5001

10-DISK DVD/CD CHANGER

Part # 9106-000-002

OWNER'S / INSTALL MANUAL

Table of Contents

Introduction and System Overview	2
System Requirements	3
Wiring Diagrams	4
R5001 to CV7000 with 9800VCP	4
R5001 to DA-2301 with DA-7169	5
R5001 to DA-7169	6
R5001 to CV6800	7
R5001 to CV6800 with R5000VCR	8
R5001 to Other Non-Rosen Equipment	9
R5001 10-Disc DVD Changer - Box Contents	10
(Optional) 10-Disc DVD Changer Interface Kit	
- Box Contents	11
Installation	12
Precautions	12
Installation Brackets and Angle	13
Remote Control Reference	16
Remote Control Button Definitions	17
Basic Functions	18
Ejecting the 10-Disc Magazine	19
Playback (DVD, CD, VCD)	19
Play / Pause (CD/MCD/DVD)	21
Muting the Sound (CD/MCD/DVD)	21
Fast Forward (CD/MCD/DVD)	21
Fast Reverse (CD/MCD/DVD)	21
Next Track or Previous Track (CD/MCD/DVD)	21
Stop (CD/MCD/DVD)	22
Advanced Functions	22
Slow Motion (VCD/DVD)	22
Search (CD/MCD/DVD)	23
Camera Angle (DVD)	24
Audio Function (VCD/DVD)	24
Subtitle (DVD)	25
DVD Menu (DVD)	25
Title Menu (DVD)	26
Display/Indicator	26
Product Specifications	27

Introduction and System Overview

Welcome to the *Installation and Operating Guide* for the Rosen R5001 10-Disc DVD Changer. The 10-Disc DVD Changer is very flexible, and can be used in the following ways:

With **R5001 - Compatible** Rosen entertainment systems:

- The R5001 10-Disc DVD Changer can connect directly to the Rosen **ClearVue 7000** system. When used with the ClearVue 7000, the 7000's remote will control all the functions of the DVD Changer.
- It also can connect directly to the Rosen **DA-2301 Tuner** when the tuner is being used with a **DA-7169 in-dash monitor**. The DA-2301's remote will control all the functions of the DVD Changer.

With other video entertainment systems:

- The R5001 DVD Changer can be connected to other systems which have auxiliary inputs. This includes the CV6800, or the DA-7169 In-Dash Monitor when not equipped with the optional DA-2301 Tuner, as well as non-Rosen systems. These installations require the optional DVD Interface kit, available from your authorized Rosen dealer (Rosen P/N 9106-0000-008). The DVD Interface kit includes an infrared remote and an infrared receiver, allowing you full access to all functions of the DVD Changer, no matter what system it is installed with.

NOTE: In order for the R5001 to be added to a system, it must have auxiliary RCA inputs for both audio and video signals.

System Requirements

The following components will be required when installing the R5001 DVD Changer:

with **ClearVue 7000**

- CV7000 FPD Kit (9100-0128-000)
- CV7000 Installation Kit (Installation Specific)

with **ClearVue 7000 and 9800 VCP:**

- CV7000 FPD Kit (9100-0128-000)
- CV7000 Installation Kit (Installation Specific)
- VCP9800R (9100-0109-000)
- VCP Signal Cable (6015-1067-000)
- VCP Power Cable (6015-1013-000)

with **DA-2301 Tuner & DA-7169 in-dash monitor**

- DA-2301 (9106-0000-003)
- DA-7169 (9106-0000-004)

with **DA-7169 In-dash monitor (w/o DA-2301)**

- DA-7169 (9106-0000-004)
- DVD Interface Kit (9106-0000-008)

with **ClearVue 6800 (no VCR)**

- CV6800 FPD Kit (9100-0129-000)
- CV6800 Installation Kit (Installation Specific)
- DVD Interface Kit (9106-0000-008)

with **ClearVue 6800 and R5000 VCR:**

- CV6800 FPD Kit (9100-0129-000)
- CV6800 Installation Kit (Installation Specific)
- DVD Interface Kit (9106-0000-008)
- R5000VCR (9100-0109-201)

Other Video Systems (with Auxiliary Inputs)

- DVD Interface Kit (9106-0000-008)

Wiring Diagrams

R5001 to CV7000 with the 9800VCP

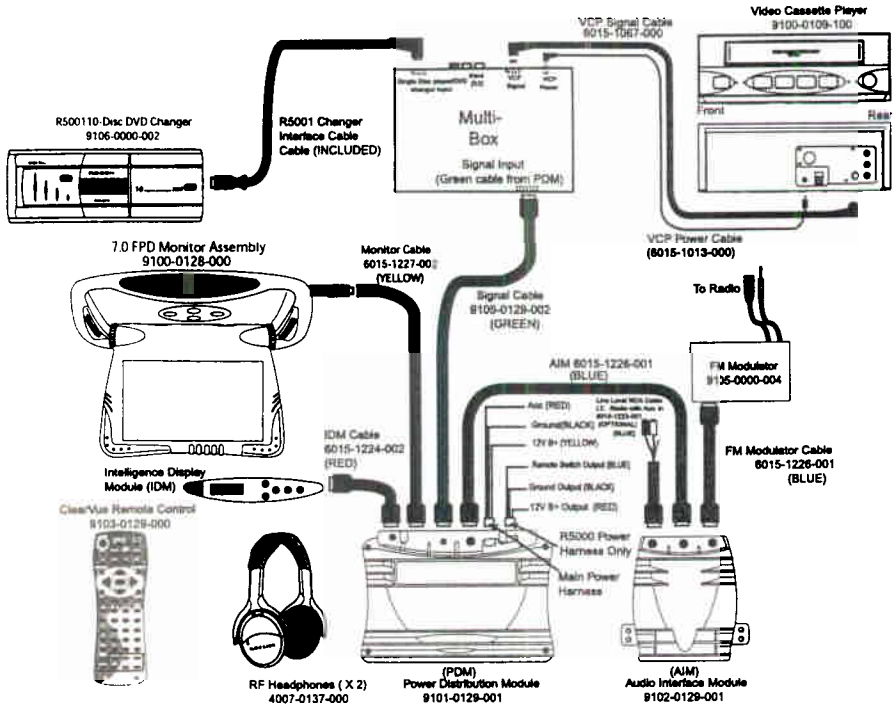

Wiring Diagrams

R5001 to DA-2301 with DA-7169

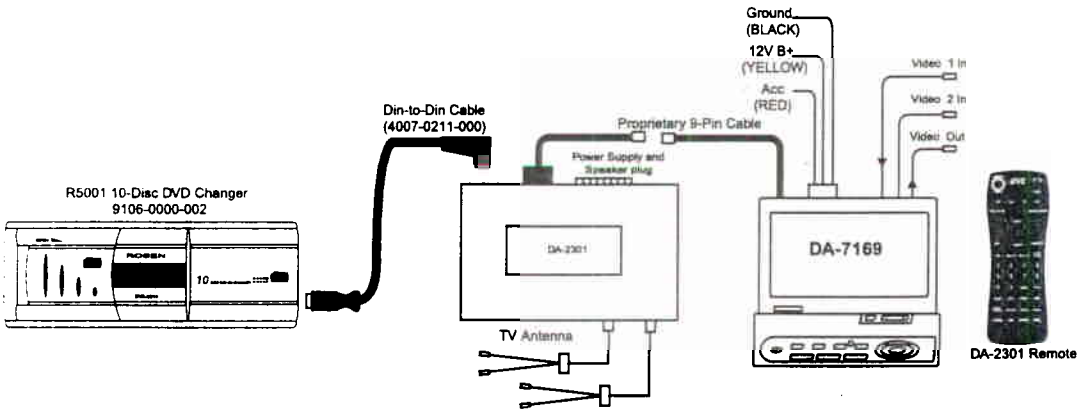

R5001 to DA-7169

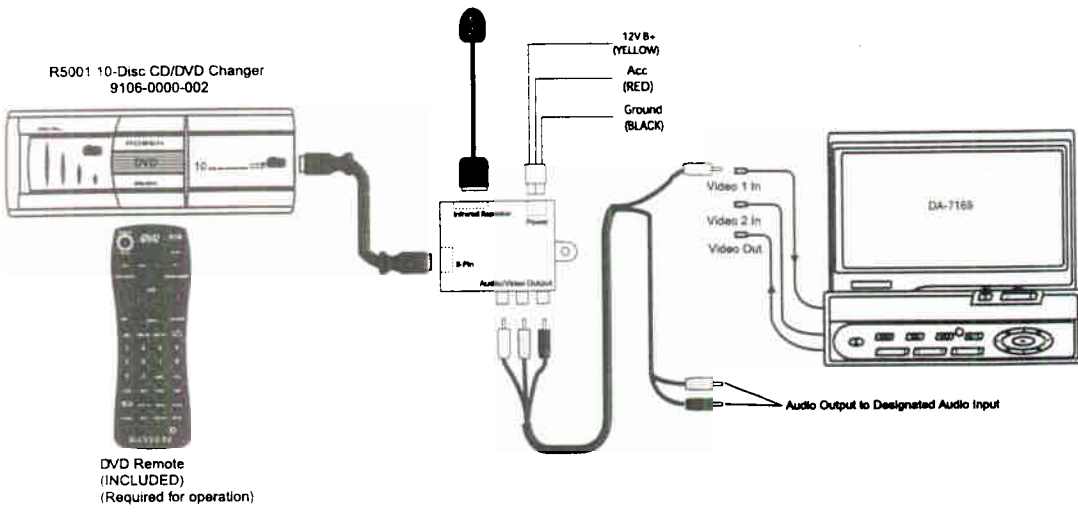

R5001 to CV68800

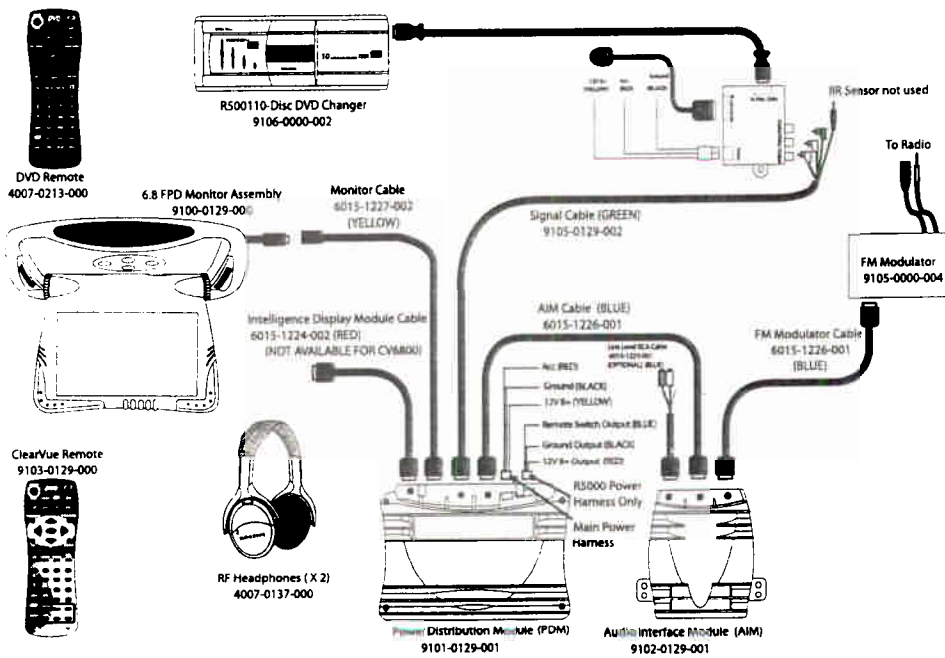

R5001 to CV6800 with R5000VCR

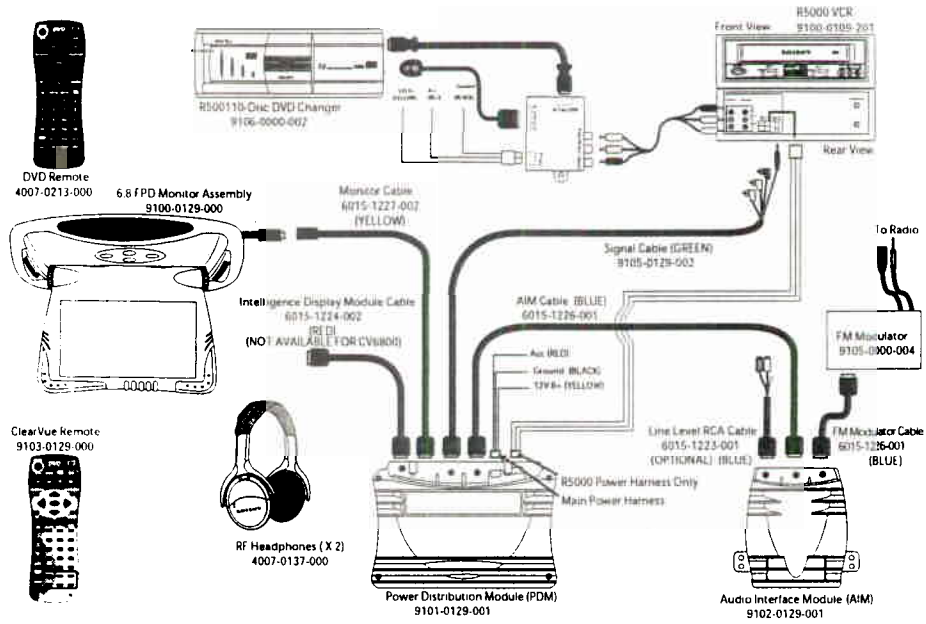

R5001 to Other Non-Rosen Equipment

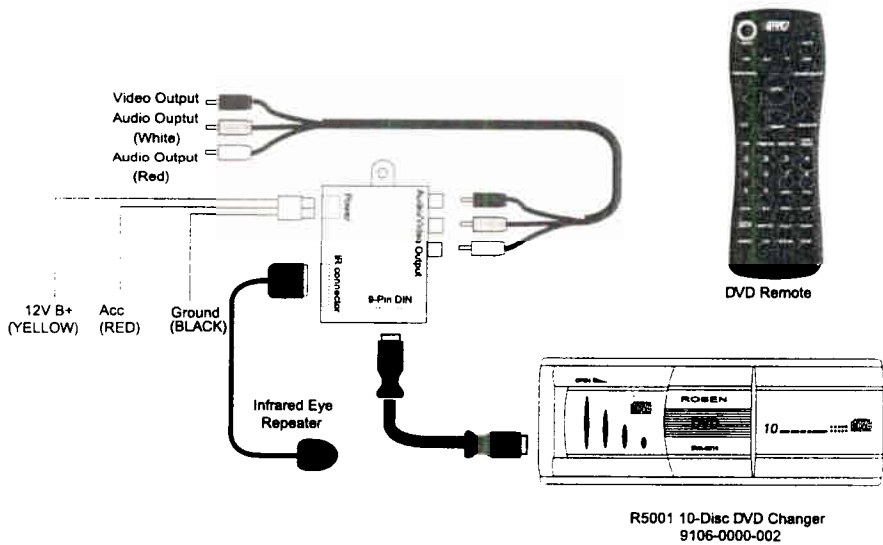

R5001 10-Disc DVD Changer - Box Contents

The Rosen R5001 10-Disc DVD Changer includes the following parts and equipment:

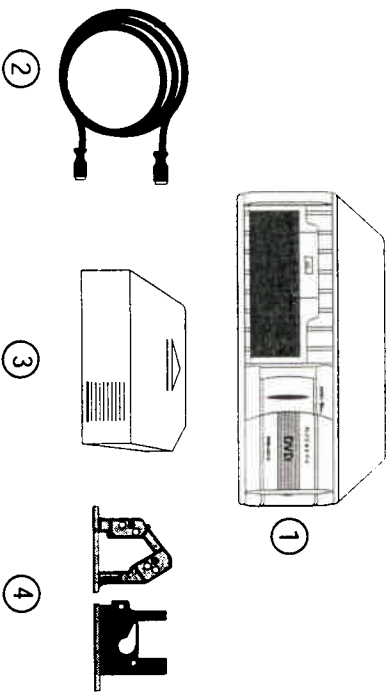

- 1 10-Disc DVD/CD Changer (4007-0209-000)
- 2 9-pin Interface Cable (4007-0211-000)
- 3 10-Disc DVD/CD Changer Magazine (4007-0212-000)
(Always load DVD/CD with the label side DOWN.)
- 4 Mounting Brackets (4007-0210-000). Bracket Notice: For use with Horizontal and Vertical installation only. Adjust retention screw according to mounting position.
- 5 This manual.

(Optional) 10-Disc DVD Changer Interface Kit - Box Contents

The optional DVD Interface Kit(9106-0000-008) includes the following parts and equipment:

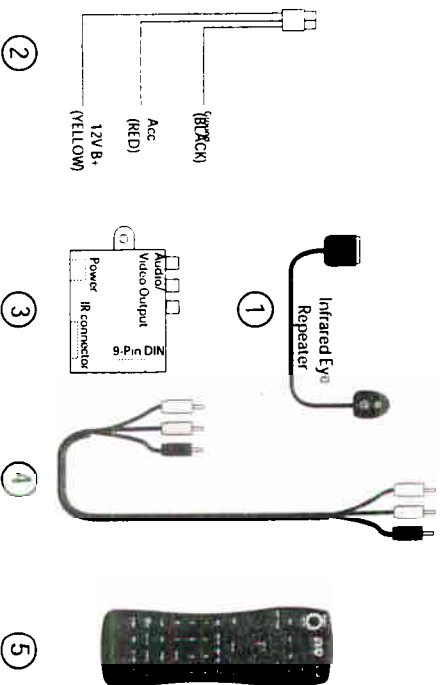

- 1 Infrared Repeater Cable (4007-0216-000)
(Must be used for other than CV7000 or DA-2310 installation.)
- 2 4-pin DVD Power Harness (4007-0217-000)
(Must be used in conjunction with DVD Distribution Box.)
- 3 DVD Distribution Box (4007-0214-000)
(Must be used for other than CV7000 or DA-2310 installation.)
- 4 RCA Audio/Video Cable (4007-0215-000)
(Must be used in conjunction with DVD Distribution Box.)
- 5 DVD Remote Control (4007-0213-000)
(Must be used for other than CV7000 or DA-2310 installation.)
- 6 DVD Interface Kit Instructions (9100-0000-804)

Installation

Precautions

Note: This unit should be installed by an authorized Rosen dealer/installer.

- This product utilizes a laser. Do not remove the cover. Use of controls or adjustments, or performance of procedures other than those specified may result in hazardous radiation exposure.
- This product is designed to operate with a 12-Volt, negative ground battery.
- Disconnect the ground wire from the vehicle battery terminal before connecting this unit to the electrical system.
- Use proper insulation, connectors, and fastening materials to prevent electrical short-circuiting.
- Do not install this product in a position that may interfere with safety restraints or standard operation of the vehicle.
- To avoid damaging the unit, use only Rosen-approved hardware and accessories. Refer to "System Requirements" on page 3 for details.
- This product was designed to be installed horizontally or vertically. Installation at a 45 degree angle is an option that requires custom brackets not included. After you select the position for your installation, be sure the four retention springs on the ends of the 10-Disc DVD Changer are positioned to match your installation. Refer to the illustration on the following page.

Installation Brackets and Angle

To install the Rosen R5001 10-Disc DVD Changer:

- 1 Select the desired location and position for the unit.

Note: Do not install this product in a position that may interfere with safety restraints or standard operation of the vehicle. Do not install this unit in a position that may cause injuries to passengers during an accident.

- 2 Adjust the four retention springs, two on each end of the changer, to match your installation. Move the spring to the H position for a horizontal installation or to V for vertical installation.

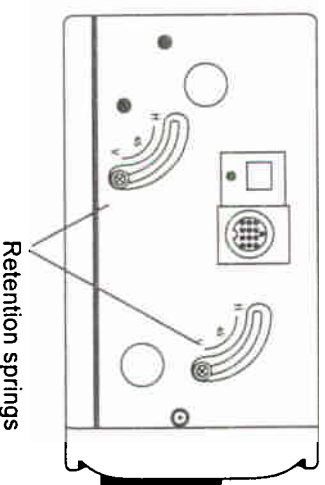

- 3 Remove the three transport screws from the bottom of the 10-Disc DVD Changer. After removing the screws, cover the holes with the seals supplied to prevent dust and dirt from entering the unit which could cause mechanical trouble.

- 4 Attach the brackets to the 10-Disc DVD Changer using screws supplied.

Note: Use the correct fasteners and connecting cables during installation to avoid possible product damage, electrical short-circuits, and risk of fire.

Horizontal Installation:

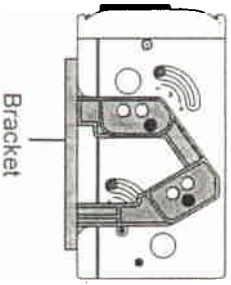

Bracket

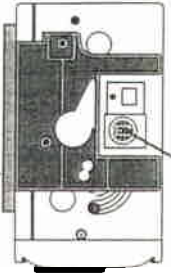

Cable Connector

Vertical Installation:

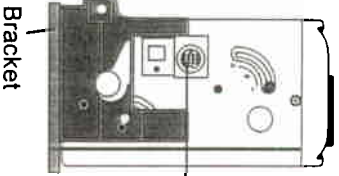
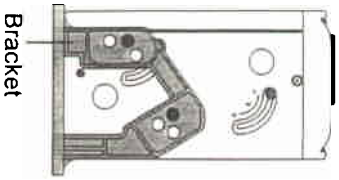

Cable Connector

- 5 Attach the 10-Disc DVD Changer to the vehicle using the screw holes in the bracket feet.

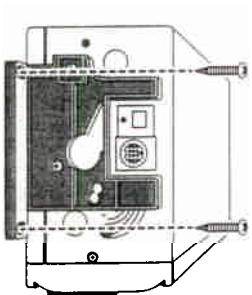
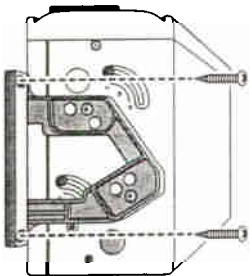

Remote Control Reference

Note: Replace Remote Control batteries regularly. To avoid damage to new batteries, do not use new and used batteries at the same time. Battery life is approximately six months.

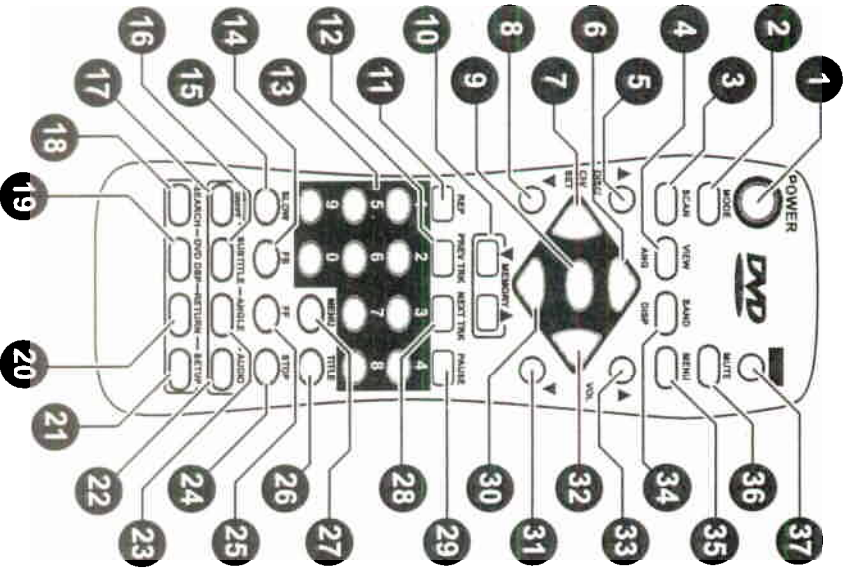

Note: The ClearVue 7000 or the DA7169 with DA-2301 Tuner automobile entertainment systems include a system Remote Control with buttons for all the functions of this unit as well as other components of the system. If you want to use a single remote, you can do so if this unit is installed in those systems.

Remote Control Button Definitions

- DVD Function Buttons
- 1 POWER
- 5 DISC/CH/SET Up
- 6 UP CURSOR
- 7 LEFT CURSOR
- 8 DISC/CH/SET Down
- 9 SAVE/ENTER
- 11 REP (Repeat)
- 12 PREV TRK
- 13 NUMERICS
- 14 FB Fast Reverse
- 15 SLOW
- 16 SUBTITLE
- 17 SUBTITLE ON/OFF
- 18 SEARCH
- 19 DVD DISP
- 20 RETURN
- 22 AUDIO
- 23 ANGLE
- 24 STOP
- 25 FF Fast Forward
- 26 TITLE
- 27 MENU
- 28 NEXTTRK
- 29 PLAY/PAUSE
- 30 DOWN CURSOR
- 32 RIGHT CURSOR
- 36 MUTE
- Not Used
- 2 MODE
- 3 SCAN
- 4 VIEW ANG
- 10 MEMORY Up/Down
- 21 SETUP
- 33 VOLUME Up
- 31 VOLUME Down
- 34 BAND/DISP
- 35 SYS MENU
- 37 EJECT

Basic Functions

All operations of the R5001 are performed by using a Remote Control. To perform a function, point the Remote Control directly at the Remote IR Sensor which is usually beside the video screen.

Notes:

- This unit was designed to be used with DVD audio discs, DVD-ROMs, CD-ROMs, and Video CDs. Functions will vary depending on the features available on the disc you are playing. The monitor displays INVALID when a corresponding operation is prohibited either by the player or by the disc, or if the disc is loaded incorrectly.
- Allow adequate air circulation to prevent internal heat buildup. Do not install unit near heat sources such as radiators or air ducts, or in a place subject to direct sunlight or excessive dust. If the internal temperature of the vehicle is extremely high, allow a short cooling down period before operating the unit.
- To reduce the risk of fire or shock hazard, do not expose this equipment to rain or moisture.
- If the unit shows signs of overheating or malfunction, power off the unit and consult your dealer immediately. Do not open the unit; there are no serviceable parts inside.

Ejecting the 10-Disc Magazine

To eject the 10-disc magazine:

- 1 Slide the bezel door to the right.
- 2 Press the Eject button above the magazine, as shown below.

Slide the door to the right to open it

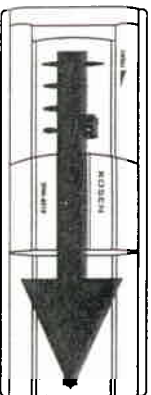

Eject button

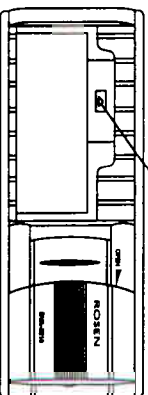

Playback (DVD, CD, VCD)

To play a disc:

- 1 Load up to 10 discs into the disc magazine with the label side down. You can load any combination of disc types: DVD, CD, or VCD.



Important! Load disc with Label Side **DOWN!**

- 2 Insert the magazine into the 10-Disc DVD Changer in the direction indicated by the arrow.

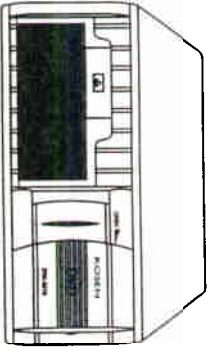

- 3 Push in the magazine until you hear a click.
 - 4 Close the bezel door.
 - 5 The 10-Disc DVD Changer initiates a disc check that identifies which slots are occupied by discs. You will hear the changer load each disc in turn as it performs this check.
 - 6 After the disc check is complete, playback of the first disc commences automatically.
- Note:** This unit was designed to be used with DVD audio discs, DVD-ROMs, CD-ROMs, and Video CDs. The monitor displays **INVALID DISC** if the disc is incompatible with the unit or if the disc is loaded incorrectly.
- 7 Press the **DISC/CH/SET** up or down arrow to select a different disc.
 - 8 If the disc begins with a menu screen on the monitor:
 - a Press the up, down, left or right arrow to select the preferred title.
 - b Press **ENTER**.
 - c To return to the menu screen, press **MENU** or **TITLE**.

Play / Pause (CD/VCD/DVD)

- Press **PLAY/PAUSE** to cycle from normal play to Pause modes.

Muting the Sound (CD/VCD/DVD)

- 1 Press **MUTE** once to mute the sound. "MUTE" appears in the monitor.
- 2 Press **MUTE** again to restore sound.

Fast Forward (CD/VCD/DVD)

- Press **FF** during playback to toggle the unit between fast forward and regular play.
- DVD or VCD playback has five fast forward speeds: 2, 4, 8, 16, and 32. Press the **FF** button to cycle through these options and regular play.
- Audio CD playback has one fast forward speed.

Fast Reverse (CD/VCD/DVD)

- Press **FB** during playback to toggle the unit between fast reverse and regular play.
- DVD or VCD playback has five fast reverse speeds: 2, 4, 8, 16, and 32. Press the **FB** button to cycle through these options and regular play.
- Audio CD playback has one fast reverse speed.

Next Track or Previous Track (CD/VCD/DVD)

- Press **NEXT TRK** during playback to skip forward to the next track or to the next title/chapter.
- "SKIP FW" appears in the monitor.

- Press **PREV TRK** during playback to skip backward to the previous track or to the previous title/chapter. "SKIP BW" appears in the monitor.

Stop (CD/VCD/DVD)

To stop a DVD or VCD:

- 1 Press **STOP** to enter PRE STOP mode. "PRE STOP" appears on the monitor. The player records the point where the **STOP** button is pressed so you can resume playback at that location after performing other functions.
- 2 Press **Play / Pause** to resume normal playback from this point.
- 3 Press **STOP** again to clear the PRE STOP function. "STOP" appears in the monitor.

Note: The PRE STOP feature is not available for Audio CDs.

To stop an Audio CD:

- 1 Press **STOP** to stop CD playback and enter STOP mode.
- 2 Press **Play / Pause** to resume normal playback from this point.

Advanced Functions

Slow Motion (VCD/DVD)

- Press the **SLOW** button to play in slow motion. The unit has 4 slow forward speeds: 2, 4, 8, and 16. Press the **SLOW** button to cycle through these options and regular play.

Search (CD/VCD/DVD)

The Search function enables you to specify a time/track/chapter or title.

To search on a DVD:

- 1 Press **SEARCH** to cycle through the following search options:
 - "Title xx"
 - "Chapter XXX"
 - "Time xx:xx:xx"
- 2 Use the numeric keys to enter the desired title, chapter, or chapter time. Press the **ENTER** button to play the selected track or time.

You can also use the numeric keys to enter the desired track without entering Search mode.

To search an Audio CD:

- Press **SEARCH** to cycle through the following options:
 - "Track xx"
 - "CD"
 - "Time xx:xx"

2. Use the numeric keys to enter the desired track number or disc time. Press the **ENTER** button to play the selected track or time.

You can also use the numeric keys to enter the desired track without entering Search mode.

Repeat Mode

The 10-Disc DVD Changer will repeat a track or chapter, a disc, or all loaded discs for continuous playback.

Press **REP** to cycle through the following on-screen display options:

For DVDs:

"RPT CHAPT" = The current chapter will be repeated
 "RPT TITLE" = The current title will be repeated
 "REPEAT OFF" = Repeat mode will be switched off

For Audio / Video CDs:

"REPEAT ONE" = The current track will be repeated.
 "REPEAT ALL" = The current disc will be repeated.
 "REPEAT OFF" = Repeat mode will be switched off.

Camera Angle (DVD)

Some DVD discs contain scenes with more than one viewing angle. For these discs, the same scene can be viewed from a different angle by using the **ANGLE** button.

To view a scene from another angle:

- 1 During DVD playback, press the **ANGLE** button. "ANGLE x/y" appears in the monitor, where x represents the current camera angle and y represents the total available camera angles.
- 2 Press the **ANGLE** button again to cycle through all available camera angles until the preferred angle is selected.

Note: This function is only available on DVDs that contain multiple viewing angles.

Audio Function (VCD/DVD)

Some DVDs and VCDs contain multiple audio tracks. For these discs, the same video can be viewed with different audio.

To change the audio on a DVD:

- 1 During DVD playback, press the **AUDIO** button. "AUDIO x/y" appears in the monitor, where x represents the current audio stream and y represents the total available audio streams.
- 2 Press the **AUDIO** button to cycle through all available audio streams until the preferred audio is selected.

To change the audio on a VCD:

- During VCD playback, press the **AUDIO** button until the desired audio is selected.

Subtitle (DVD)

Some DVDs include subtitles in one or more languages.

To change subtitles to a different language:

- 1 Press the **SUBTITLE ON/OFF** button to cycle between "SUBTITLE ON" and "SUBTITLE OFF" modes.
- 2 During DVD playback with "SUBTITLE ON" mode selected, press the **SUBTITLE** button. "SUBTITLE x/y" appears in the monitor, where x represents the current subtitle and y represents the total available subtitles. Press the **SUBTITLE** button to cycle through all available subtitles until the preferred subtitle is selected.

Note: **SUBTITLE** works only for discs that have multiple subtitle options.

Note: In some cases, the subtitle change is not immediate.

DVD Menu (DVD)

Most DVD discs have unique menu structures. DVD menu contents and operation may differ from disc to disc.

To use DVD menus:

- 1 During DVD playback, press the **MENU** button. The DVD menu available on the disc appears in the monitor.

- 2 Use the up, down, left and right arrows to select the preferred menu option.
 - 3 Press **ENTER** when the desired option is selected.
- Title Menu (DVD)**
- Some DVD discs may include more than one title.
- To change titles:
- 1 During DVD playback, press the **TITLE** button. A list of the titles available on the DVD appears in the monitor.
 - 2 Use the up, down, left and right arrows to select the preferred item.
 - 3 Press the **ENTER** button when the desired option is selected.

Display Function (CD/VCD/DVD)

The **DVD DISP** function enables you to view the status, current title number, track number and the total playing time of the disc on the monitor.

To display status information for DVDs:

- Press the **DVD DISP** key repeatedly to view the following information in the monitor:

"CTIME" = Chapter time
 "CRTIME" = Chapter remaining time
 "TTIME" = Title time
 "TRTIME" = Title remaining time

To display status information for Audio CDs:

- Press the **DVD DISP** key repeatedly to cycle through the following information:
- "TTIME" = Track time
 "TRTIME" = Track remaining time
 "DTIME" = Disc time
 "DRTIME" = Disc remaining time

Product Specifications

GENERAL

Power Supply	: 12VDC Typical
Current Consumption	: Less than 3.0 A
Operating positions	: Horizontal or Vertical
Dimension (WxHxD)	: 178 x 50 x 190 mm
Weight	: 2.0 kg

AUDIO

Output	: 700mV rms, 600Ω
Frequency response	: 20 Hz to 20 KHz (CD audio / 44.1kHz sampling)
Distortion	: 0.02% (at 1 kHz)
Dynamic range	: Above 85dB
S/N ratio	: ≥ 90dB
Cross talk	: -75dB
Optical output	: Connection to optional DSP unit for 5.1 channel Dolby™ Digital & dts™ sound reproduction

VIDEO

Television System	: NTSC
Playback Disc	: DVD/VCD/CD & CD-R compatible 12cm
Aspect Ratio	: 4:3, 16:9
TV Encoder Resolution	: 10 bit DAC
Video S/N	: 65 dB

Compatible Equipment

Rosen P/N

ClearVue 7000 7.0" Video system	9100-0128-000
DA-2301 tuner when in use with DA-7169 7.0" in-dash monitor	9106-0000-003 9106-0000-004

Optional Equipment

DVD Interface Kit	9106-0000-008*
Additional 10-disc magazine	4007-0212-000

*Includes RS5001 remote, infrared receiver, and adapter cables for use with systems other than the CV7000 and DA-2301/DA-7169.
 Manufactured under license from Dolby Laboratories. Dolby and Double-D symbols are trademarks of Dolby Laboratories. Copyright © 1999. All rights reserved.