

OWNER'S MANUAL

Mobile Video System

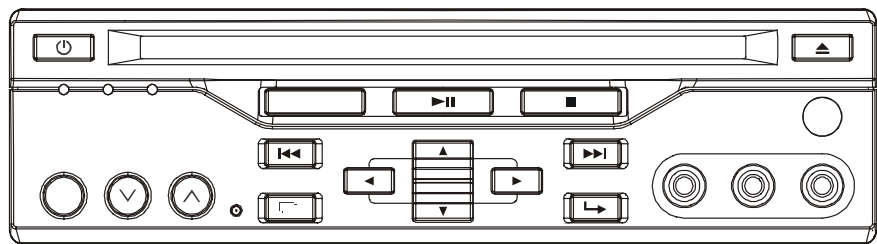
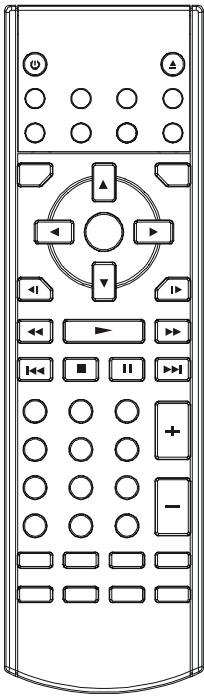

- **Digital Audio Out-Coaxial**
- **Multi-subtitle Languages Function**
- **Multi-audio Languages Function**
- **Multi-angle Function**
- **Parental Control**
- **Remote Control**

□ **Features**

Compatible with PAL DVD (Video CD) and NTSC DVD (Video CD)

This player can play discs recorded in either PAL or NTSC format.

- A single LSI chip now integrates all major DVD playback circuit functions including MPEG2 decoder, video D/A converter, and audio decoders.
- L/R stereo analog audio outputs for connection to existing head unit aux inputs. Video output is composite video.
- Supplied remote handles multi-function software (multi-language audio-track/subtitle, multi-angle, multi-story, etc.), plus all basic functions.

□ **Use This Product Safely**

When Driving

Keep the volume level low enough to be aware of road and traffic conditions.

When Car Washing

Do not expose the product to water or excessive moisture. This could cause electrical shorts, fire or other damage.

When Parked

Parking in direct sunlight can produce very high temperatures inside your vehicle. Give the interior a chance to cool down before starting playback.

Use the Proper Power Supply

This product is designed to operate with a 12 volt DC, negative ground battery system the regular system in a North American car).

Protect the Disc Mechanism

Avoid inserting any foreign objects into the slot of this player.

Failure to observe this may cause malfunction due to the precise mechanism of this unit.

Use Authorized Service Centers

Do not attempt to disassemble or adjust this precision product. Please refer to the Service Center list included with this product for service assistance.

For Installation

The unit should be installed in a horizontal position with the front end up at a convenient angle, but not more than 30°.

CONTENTS

Safety Information	4
Disc Notes	5
The Player	7
Front View	7
Back View.....	8
Installation	9
Electric Connection	10
Remote Control	11
Location and Function of Keys	11
Preparing the Remote Control.....	13
Loading/Ejecting a disc	14
Loading a disc	14
Ejecting a disc	14
Operation	15
Basic Play.....	15
On-Screen Display Function.....	18
Multi-audio Language Function	19
Menu Function.....	19
Title Menu Function	19
Subtitle Language Function.....	19
Multi-angle Function	19
MP3 Disc Play	20
Setup	21
Initial Setup.....	21
General Setup	21
Speaker Setup.....	23
Audio Setup.....	23
Preferences Setup.....	24
Defaults Table.....	26
Specifications	27

SAFETY INFORMATION

CAUTION:

MOBILE DVD PLAYER IS A CLASS I LASER PRODUCT. HOWEVER THIS MOBILE DVD PLAYER USES A VISIBLE/INVISIBLE LASER BEAM WHICH COULD CAUSE HAZARDOUS RADIATION EXPOSURE IF DIRECTED. BE SURE TO OPERATE THE MOBILE DVD PLAYER CORRECTLY AS INSTRUCTED.

USE OF CONTROLS OR ADJUSTMENTS OR PERFORMANCE OF PROCEDURES OTHER THAN THOSE SPECIFIED HEREIN MAY RESULT IN HAZARDOUS RADIATION EXPOSURE.

DO NOT OPEN COVERS AND - DO NOT REPAIR YOURSELF. REFER SERVICING TO QUALIFIED PERSONNEL.

WARNING:

- TO REDUCE THE RISK OF FIRE OR ELECTRIC SHOCK, DO NOT EXPOSE THIS EQUIPMENT TO RAIN OR MOISTURE.
- TO REDUCE THE RISK OF FIRE OR ELECTRIC SHOCK, AND ANNOYING INTERFERENCE, USE ONLY THE RECOMMENDED ACCESSORIES.
- THIS DEVICE IS INTENDED FOR CONTINUOUS OPERATION.

This product incorporates copyright protection technology that is protected by method claims of certain U.S. patents and other intellectual property rights owned by Macrovision Corporation and other rights owners. Use of this copyright protection

technology must be authorized by Macrovision Corporation, and is intended for home and other limited viewing uses only unless otherwise authorized by Macrovision Corporation. Reverse engineering or disassembly is prohibited.

Region Management Information

Region Management Information: This Mobile DVD Player is designed and manufactured to respond to the Region Management Information that is recorded on a DVD disc. If the Region number described on the DVD disc does not correspond to the Region number of this Mobile DVD Player, this Mobile DVD Player cannot play this disc.

DISC NOTES

Disc formats supported by this player

 **DVD**
12 cm disc
(Single-sided disc only)

 **Video CD**
12 cm disc

 **CD**
12 cm disc

 **MP3**
12 cm disc

Discs which cannot be played with this player

- DVD-ROM
- DVD-R/ DVD-RAM
- CDV
- CD-G

Handling and Cleaning

- Dirt, dust, scratches and warping discs will cause misoperation.
- Do not place stickers or make scratches on discs.
- Do not warp discs.
- A disc should always be kept in its case when not in use to prevent from damaging.
- Do not place discs in the following places:
 1. Direct sunlight.
 2. Dirty, dusty and damp areas.
 3. Near car heaters.
 4. On the seats or dashboard.

Disc Cleaning

Use a dry soft cloth to wipe the surface. If the disc is quite dirty, use a soft cloth slightly moistured with isopropyl (rubbing) alcohol. Never use solvents such as benzine, thinner or conventional record cleaners as they may mar the surface of the disc.

Note:

A disc may become somewhat scratched (although not enough to make it unusable) depending on you handle it and conditions in the usage environment. Note these scratches are not an indication of any problem with the player.

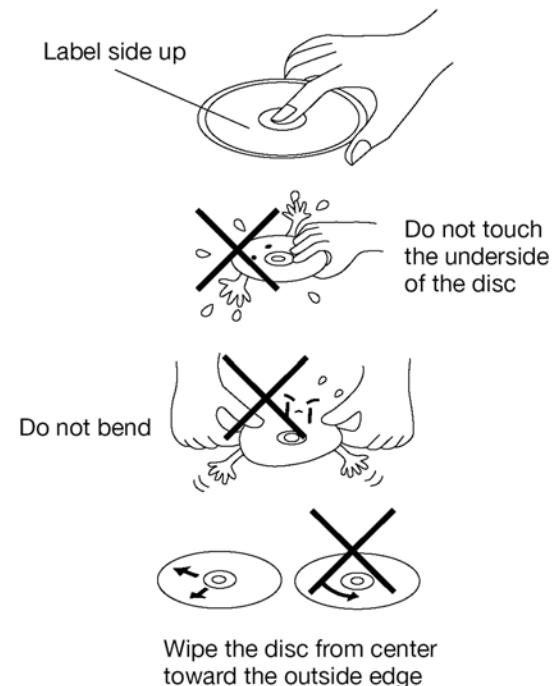

DISC NOTES

□ **Preparing New Discs with Rough Spots**

A new disc may have rough edges on its inside and outside edges. If a disc with rough edges is used, the proper setting will not be performed and the player will not play the disc. Therefore, remove the rough edges in advance by using a ballpoint pen or pencil as shown on the right. To remove the rough edges, press the side of the pen or pencil against the inside and outside edges of the disc.

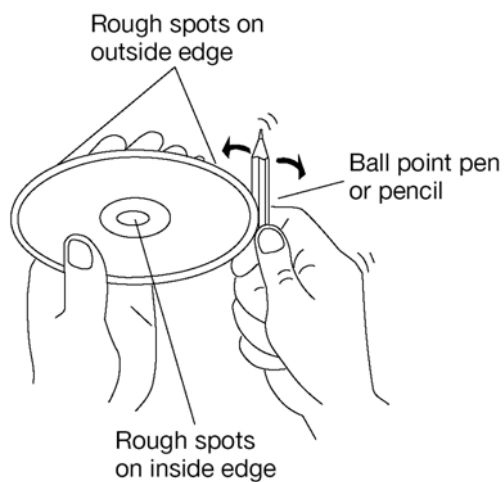

THE PLAYER

FRONT VIEW

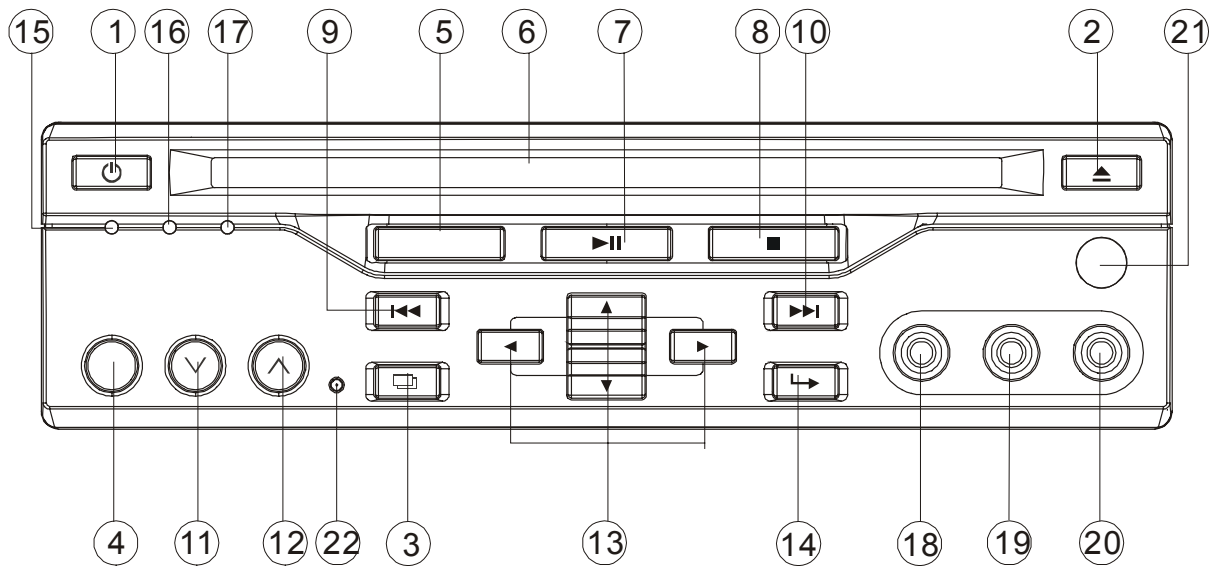

- | | |
|---------------------|------------------------------------|
| 1. POWER (⏻) | 12. VOLUME ^ |
| 2. EJECT (⏏) | 13. ◀/▶, ▲/▼ cursor buttons |
| 3. SETUP | 14. ENTER |
| 4. AUD | 15. Indicator Light for DVD |
| 5. SOURCE | 16. Indicator Light for AV INPUT 1 |
| 6. Disc Slot | 17. Indicator Light for AV INPUT 2 |
| 7. PLAY/PAUSE (▶) | 18. VIDEO IN 1 |
| 8. STOP (■) | 19. AUDIO IN 1 L |
| 9. PREVIOUS (◀◀) | 20. AUDIO IN 1 R |
| 10. NEXT (▶▶) | 21. IR |
| 11. VOLUME v | 22. Reset button |

THE PLAYER

BACK VIEW

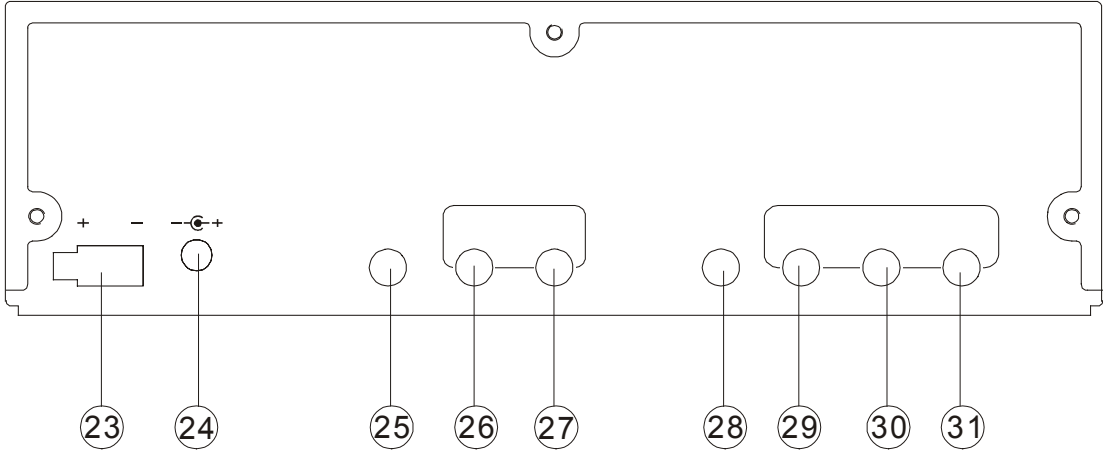

- 23. DC 12V INPUT Socket
- 24. DC 12V OUTPUT Socket
- 25. REMOTE Socket
- 26. VIDEO 2 INPUT
- 27. AUDIO 2 INPUT L/R

- 28. DIGITAL AUDIO
- 29. VIDEO 1 OUTPUT
- 30. AUDIO OUTPUT L/R
- 31. VIDEO 2 OUTPUT

INSTALLATION

This unit is designed for home-use and car-use. When installed on the car, please follow the installation instruction below.

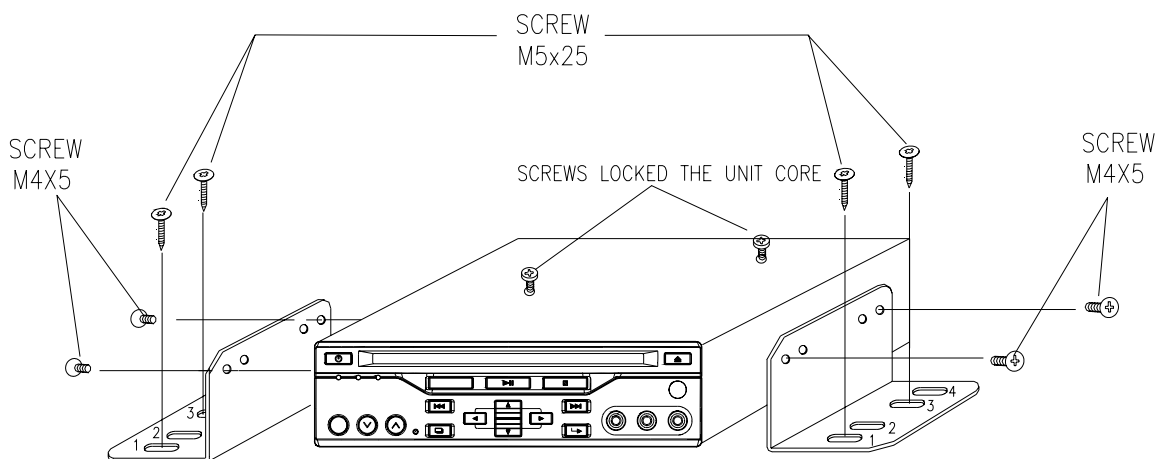

Note:

1. First remove the two screws that lock the unit core, then attach the brackets on both sides of unit with screws (M4x5), last install the unit with screws (M5x25).
2. When fix the unit, you can slide the screw (M5x25) to left side or right side to meet your needed position. In the figure below, select two holes among the positions that marked 1,2,3 and 4 to fix the bracket.

ELECTRICAL CONNECTION

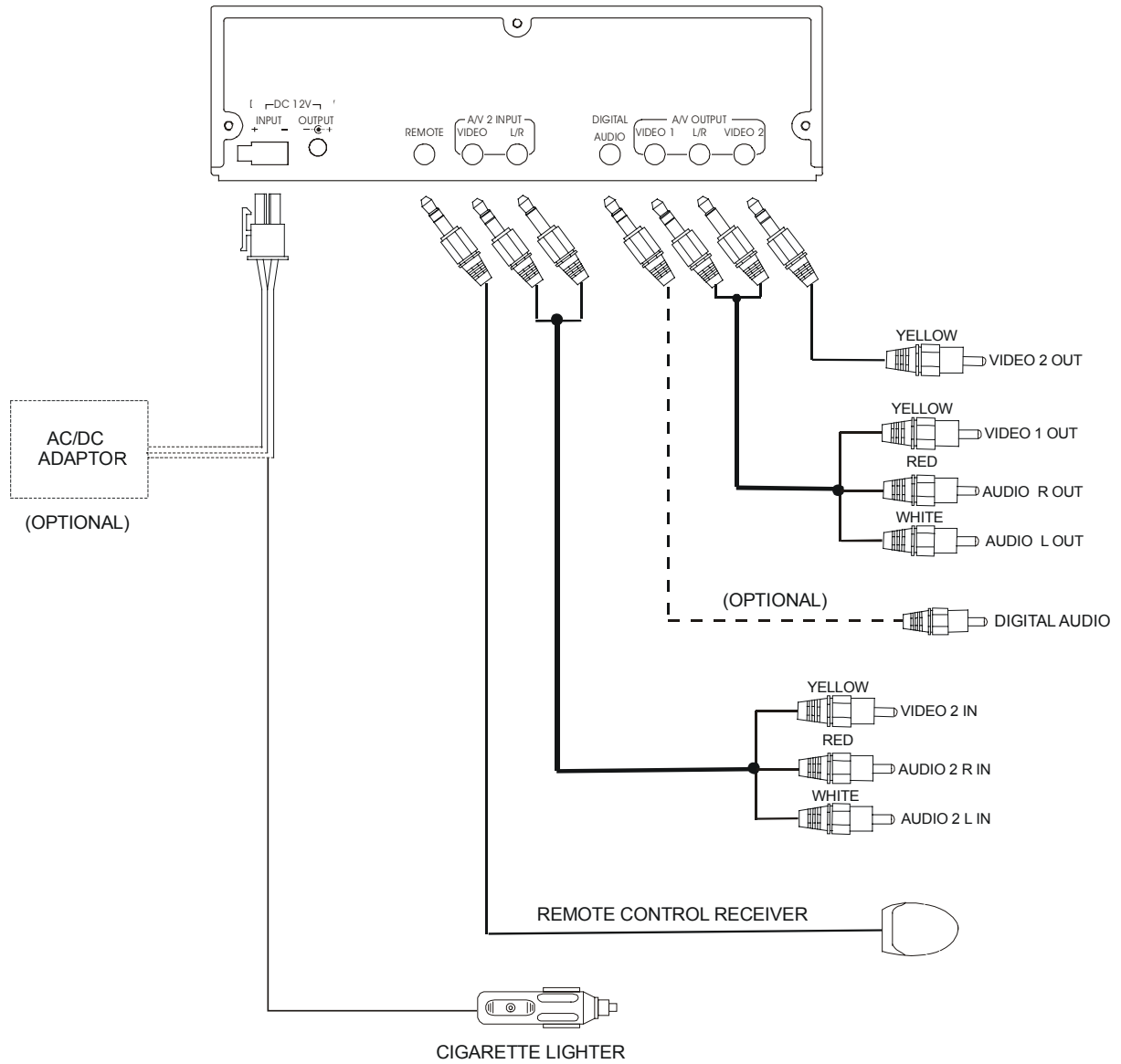





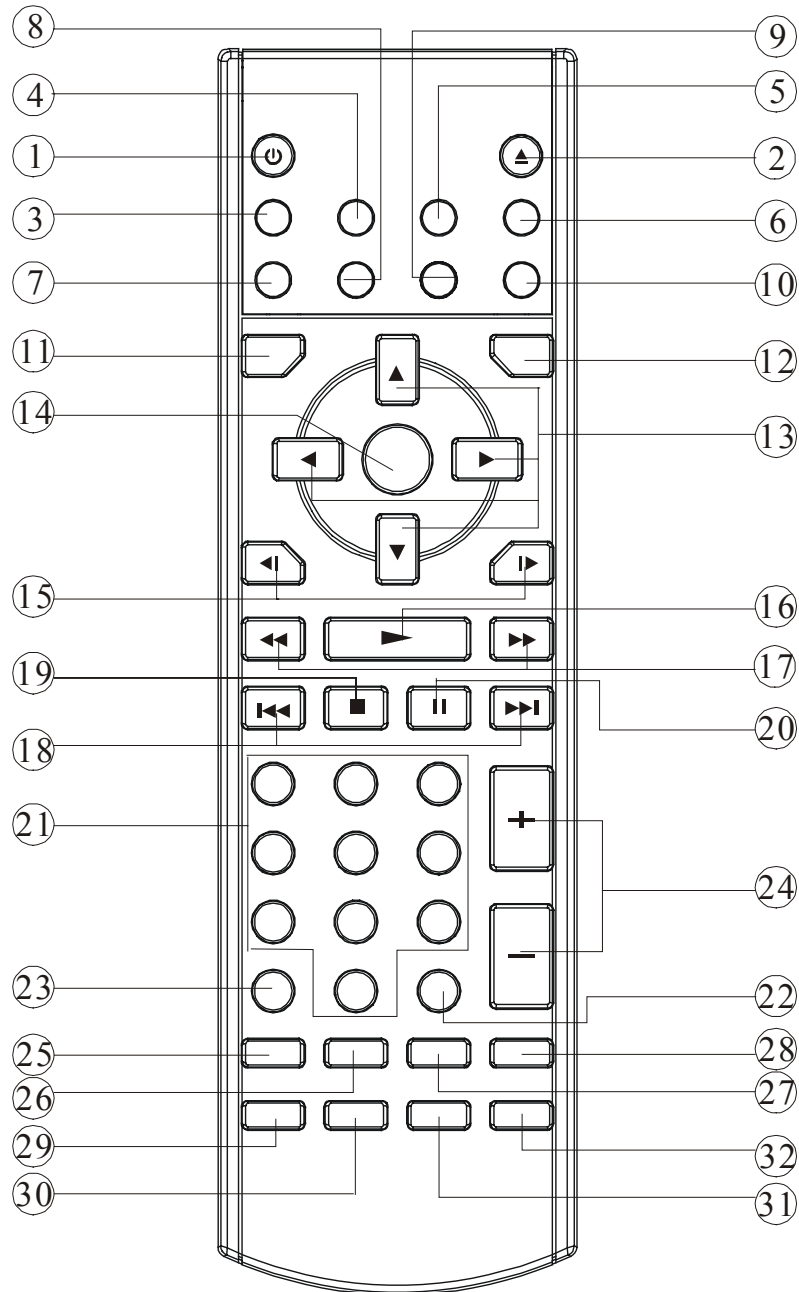

















REMOTE CONTROL

LOCATION AND FUNCTION OF KEYS



REMOTE CONTROL

1.  POWER Press POWER to turn the unit ON or OFF.
2. EJECT Press to eject the disc.
3. MUTE Press to mute the sound.
4. SUBTITLE Changing of the SUBTITLE language on multi-subtitle language DVD disc.
5. ANGLE Changing of the view angle on multi-angle DVD disc.
6. DISPLAY Display statistical disc information during playback.
7. MODE Changing between DVD mode, AV1 mode and AV2 mode.
8. SETUP Display the SETUP menu.
9. PAL/NTSC Switch between PAL mode and NTSC mode.
10. AUDIO Changing of the AUDIO soundtrack on multi-audio soundtrack DVD disc.
Changing of the sound mode of the VCD/CD discs.
11. TITLE Display the TITLE menu that is stored in DVD disc.
12. MENU Display the root menu that is stored on the DVD disc.
13. , , ,  In case of MENU mode, , , ,  buttons served as cursor buttons to select item left/right, ahead/back.
14. ENTER Confirm the Track/Chapter selected with the numeric buttons or selected with the cursor buttons on TV screen.
15. /  Changing for slow forward/ reverse playback motion.
16.  Press to play the disc.
17. /  Press  to search forward rapidly &  to search reverse rapidly.
18. /  Press  to skip to the next track & press  to skip back one track.
19.  Press it to stop playback.
20.  Press it to pause playback.
21. 0-9 Numeric buttons
22. 10+ Digital selecting button, cooperatively used with numeric buttons.
23. CLEAR When you input a number in error, press the button to clear it.
24. VOLUME+/- Press VOLUME+/- button to increase or decrease the volume level.
25. ZOOM Allows the picture to be increased or decreased in size.
26. RESUME When in stop mode, press the button, the play can be resumed from the stop point.
27. GOTO Disc search button, cooperatively used with numeric buttons.
28. PBC Changing between PBC ON and PBC OFF on the VCD disc.
29. RANDOM Allows the track played in random order.
30. PROGRAM Allows the track played in the order you programmed.
31. REPEAT Switch the Repeat mode of discs.
32. A-B A-B repeat allows a passage to be repeated continuously.

REMOTE CONTROL

Preparing the Remote Control

Inserting the Batteries

1. Open the battery compartment cover.
 2. Insert the new batteries. Make sure that the positive and negative terminals of the batteries are oriented indicated.
 3. Close the cover.
- Battery: Two AAA size battery

Using the Remote Control

Face the remote control towards the player front face **IR** mark (remote control signal receiver).

Operation angle: About ± 30 degree in each the direction of the front of the IR mark.

LOADING/EJECTING A DISC

Loading a Disc

1. Turn the ignition on to the accessory position.
2. Press the **POWER** button (1).
3. Insert the disc with printed side facing up into the disc slot (2).
4. The player will start playback automatically.

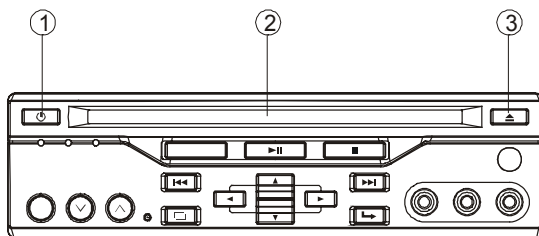

Ejecting a Disc

Press **▲** (EJECT) button (3) to eject the disc.

OPERATION

BASIC PLAY

Stopping play

- Brief press the ■ (Stop) button to stop the unit playback, when press the ► (Play) button it can continue normal playback.
- Press ■ (Stop) button twice, it will stop the playback and go back to initial Track/Chapter.

Rapid forward / Rapid reverse

Press ►► & ◀◀ during play.

Each time the button is pressed, the speed of rapid forward /reverse changes according to the disc as follow.

DVD:

Normal playback → 2X → 4X → 6X → 8X

VCD/CD:

Normal playback → 1X → 2X → 3X → 4X

MP3:

Normal playback → 2X → 4X

Skipping track

Press ►►/◀◀ buttons on the remote control or on the front panel during playback.

Press ►►► to skip to next track, and ◀◀◀ to back one track.

Note: For some VCD2.0 discs (PBC-playback control), ►►/◀◀ buttons may be unavailable.

Slow motion play

Press ◀◀/►► during play.

Each time the button is pressed, the speed of slow forward /reverse changes according to the disc as follow.

DVD:

Normal Playback → 2X → 4X → 8X

Pause (still picture)

Pressing || on the remote control or ►|| on the front panel during playback will stop play temporary. To return to normal playback, press ► on the remote control or ►|| on the front panel.

MUTE

Will mute the sound, but the disc continues playing. When you unmute the sound (press MUTE again), a later passage will be playing.

REPEAT

FOR DVD:

Press **REPEAT** button to select repeat mode as follow:

CHAPTER REPEAT ON → TITLE REPEAT ON
← REPEAT OFF ←

FOR VCD/CD:

Press the REPEAT button to select repeat mode as follow.

REP-ONE → REP-ALL → REPEAT OFF
←

1. Continuously repeat at the current chapter/track, when selected REP-ONE mode.
2. Select REP-ALL mode to continuously repeat all chapter/track on the current disc.
3. When the player finish playback the current disc last chapter/track, it will stop display the elapsed time. When selected REPEAT OFF mode, REP-ONE & REP-ALL disappear at the screen display.

BASIC OPERATION

4. REPEAT feature not support VCD2.0 (with PBC ON).

A-B

A-B repeat allows a passage to be repeated continuously. Press **A-B** button at the start of the required passage, then press **A-B** button again at the end of the passage. To revert to normal playing, press **A-B** button again. Each time the button pressed, the screen will display as follows:

A TO B SET A → A TO B SET B → A TO B CANCELLED

Disc Search (GOTO)

FOR DVD

Press **GOTO** button twice, the screen will display the following message:

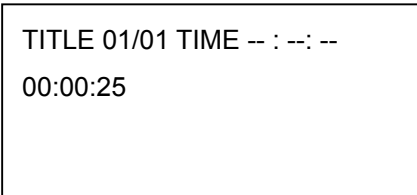

```
TITLE 01/01 TIME -- : -- : --
00:00:25
```

You can select the item you want to watch through TIME setting by using numeric buttons and ENTER key.

FOR CD/VCD (WITH PBC OFF):

Press **GOTO** button once, the screen will display the following message:

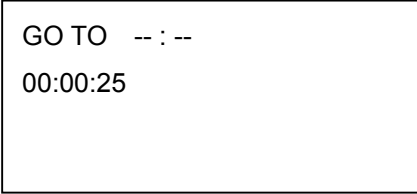

```
GO TO -- : --
00:00:25
```

Use numeric buttons to input the time directly.

ZOOM

Allows the picture to be increased or decreased in size. Press **ENTER** to toggle among 1.5 scale, 2.0 scale and 3.0 scale.

RANDOM

Press **RANDOM** button, track selection will be made in random order. The display screen will show "SHUFFLE ON" on the right-top corner. Press **RANDOM** button again, "SHUFFLE OFF" appears and release the mode.

PROGRAM

In stop mode, press **PROGRAM** button, the screen will display "PROGRAM P00:00". For example: press numeric button 4 and **▶** button, "PROGRAM P01:04" appears. It means track 4 will be played first.

MODE SELECTION

Press **SOURCE** button on the front panel of the unit or **MODE** button on the remote control to select among DVD, AV1 and AV2 mode. When select one mode, the corresponding indicator on the front panel will be illuminated.

Volume Level Adjustment

Press **VOLUME** \wedge/\vee on the front panel or **VOLUME** +/- on the remote control to increase or decrease the volume level.

Remote Sensor (IR)

Point the remote handset to the remote sensor **IR** on the front panel. Receive the signal from remote handset.

Turning the player on/off

Press the ⏻ (**POWER**) button on the front panel or on the remote control to turn the player on or off.

OPERATION

Reset

Reset button is placed on the front panel and must be activated with either a ballpoint pen or thin metal object. The reset button is to be activated for the following reasons:

- Initial installation of the unit when all wiring is completed.
- All the function buttons do not operate.
- Error symbol on the display.

OPERATION

On-Screen Display function

Press the **DISPLAY** button during playback to display the contents of the current disc on the screen.

Example:

DVD:

- (1) Press **DISPLAY** for the first time:

```
TITLE 01/03 CHAPTER 002/025
00:02:25
```

Title Number, Total Title Number, Chapter Number, Total Chapter Number of this Title of the disc currently being played will be shown on the screen, along with the elapsed time.

- (2) Press **DISPLAY** for the second time:

```
TITLE REMAIN
01:46:58
```

- (3) Press **DISPLAY** for the third time:

```
CHAPTER ELAPSED
00:00:24
```

- (4) Press **DISPLAY** for the fourth time:

```
CHAPTER REMAIN
00:01:39
```

- (5) Press **DISPLAY** for the fifth time:

The message on the screen will be cleared.

VCD:

- (1) Press **DISPLAY** for the first time:

```
SINGLE ELAPSED
00:00:25
```

- (2) Press **DISPLAY** for the second time:

```
SINGLE REMAIN
00:03:15
```

- (3) Press **DISPLAY** for the third time:

```
TOTAL ELAPSED
00:00:25
```

- (4) Press **DISPLAY** for the fourth time:

```
TOTAL REMAIN
00:40:35
```

- (5) Press **DISPLAY** for the fifth time:

The message on the screen will be cleared.

CD:

- (1) Press **DISPLAY** for the first time:

```
SINGLE ELAPSED
00:00:25

TOTAL TRACK:14
TRACK: -01
```

- (2) Press **DISPLAY** for the second time:

```
SINGLE REMAIN
00:03:15

TOTAL TRACK:14
TRACK: -01
```

- (3) Press **DISPLAY** for the third time:

```
TOTAL ELAPSED
00:00:25

TOTAL TRACK:14
TRACK: -01
```

- (4) Press **DISPLAY** for the fourth time:

```
TOTAL REMAIN
00:40:35

TOTAL TRACK:14
TRACK: -01
```

OPERATION

(5) Press **DISPLAY** for the fifth time:

The message on the screen will be cleared.

MP3 (when set to NO MENU in SMART NAV item):

(1) Press **DISPLAY** for the first time:

CHAPTER ELAPSED 00:00:25
TOTAL TRACK: 123 TRACK: -01

(2) Press **DISPLAY** for the second time:

CHAPTER REMAIN 00:04:25
TOTAL TRACK: 123 TRACK: -01

(3) Press **DISPLAY** for the third time:

The message on the screen will be cleared.

Multi-audio language function For DVD

Press **AUDIO** on the remote control or **AUD** button on the front panel during playback. Each time the button is pressed, number of the audio soundtrack language changes on sequential order.

Notes:

- The language number is different according to the disc.
- Some discs only contain one language soundtrack.
- When no different language soundtrack are recorded,  will be displayed at screen left top corner.

For VCD/CD

Press **AUDIO** on the remote control or **AUD** on the front panel during playback. It is possible to switch the sound between monaural and stereo sound.

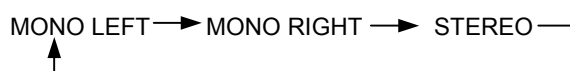

MENU function (For DVD Only)

Press **MENU** button while the disc is playing and the disc root menu will be displayed. You can navigate with the remote control navigation keys and select a feature with the **ENTER** key.

TITLE menu function (For DVD Only)

If the DVD has multiple titles recorded on the disc. It can select preferred title from the title menu to start playback.

1. Press **TITLE** during playback.
 - The title menu is display.
2. Press the cursor button shown in TV screen, select preferred title by the cursor button and confirmed by **ENTER** key.

Multi-subtitle language function (For DVD only)

Press **SUBTITLE** during playback. Each time the button is pressed, number of the subtitle language changes in sequential order.

Notes:

- The language number is different according to the disc.
- Some discs only contain one subtitle language.
- When no different subtitle language are recorded,  will be displayed at screen left top corner.

Multi-angle function (For DVD only)

Press **ANGLE** during playback. Each time the button is pressed, number of the angle changes in sequential order.

Notes:

- The angle number is different according to the disc.
- The function only works for discs having scenes recorded at different angles.

OPERATION

- When no different angle is recorded,  will be display at screen left top corner.

Note: The FOLDER cannot be selected during playing. It can be selected after  (Stop) button pressed.

MP3 Disc Play

MP3 disc is playing as the format of FOLDER. For example:

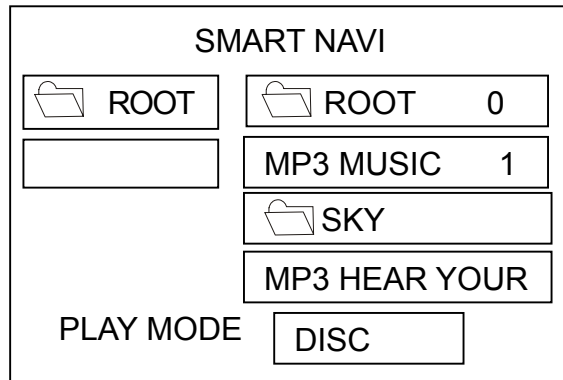

Use ▲/▼, ◀/▶ on the remote control or on the front panel of the unit to select the item or folder, then press **ENTER** button.

Pressing **REPEAT** button repeatedly can select three kind of repeat play mode.

REP-ONE: Play the same song over and again.

FOLDER REP: Play all songs in the current directory in sequence, over and again.

FOLDER: Play all songs in the current directory once.

When select PLAY MODE, press ▲/▼ to change between the following mode:

SINGLE→REP-ONE→FOLDER→FOLDER REP→
 DISC SCAN→→DISC REP→RANDOM→
 SHUFFLE ON→PROGRAM PXXX

In the playback, use ▲or▼ to skip an item ahead or back.

◀◀: Rapid reverse, ▶▶: Rapid advance.

SETUP

INITIAL SETUP

SETUP MANU --- MAIN PAGE

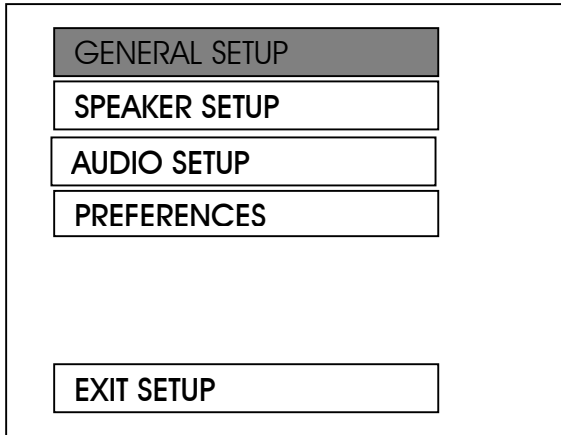

1. Press **SETUP** on the remote control or on the front panel in the stop mode. (Press the stop button twice to ensure the player under STOP mode.)
2. The initial SETUP menu is displayed.
3. Select the preferred item by using the **▲/▼** buttons.
4. Press **ENTER** buttons.
 - a/. **GENERAL SETUP**
This setup page includes all the item of TV display & Audio output feature. The detail please refer to **GENERAL SETUP MENU**.
 - b/. **SPEAKER SETUP**
This is to activate the audio output from DOLBY AC3 5.1 DOWNMIX to 2 channel mode. Please refer to **SPEAKER SETUP MENU**.
 - c/. **AUDIO SETUP**
This setup page includes all the items for AUDIO. Please refer to **AUDIO SETUP MENU**.
 - d/. **PREFERENCES SETUP**
This setup page includes all the configuration of support feature. The detail please refer to **PREFERENCES SETUP MENU**.

GENERAL SETUP

-- GENERAL PAGE --

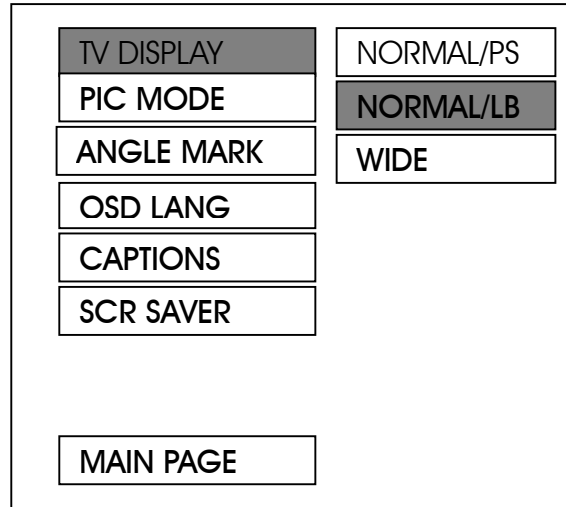

Video Material	TV Screen			
	4:3			Wide (16:9)
	Normal	Pan Scan	Letter-box	
4:3				
16:9				

TV display setup

This is to select the appropriate TV aspect (4:3 or 16:9) according to the connected TV set.

Normal/PS (For 4:3 TV)

Played back in the PAN & SCAN style. (If connected to wide-screen TV, the left and right edges are cut off.)

Normal/LB (For 4:3 TV)

Played back in letterbox style. (If connected to wide-screen TV, black bands appear at top and bottom of the screen.)

Wide (For 16:9 TV)

Select when a wide-screen TV set is connected.

SETUP

-- GENERAL PAGE --

TV DISPLAY	
PIC MODE	AUTO
ANGLE MARK	HI-RES
OSD LANG	N-FLICKER
CAPTIONS	
SCR SAVER	
MAIN PAGE	

PIC mode setup

Select AUTO, the player PIC mode will depend on DVD disc.

Select HI-RES format for best image resolution.

Select N-FLICKER format on image or picture under noise affect.

-- GENERAL PAGE --

TV DISPLAY	
PIC MODE	
ANGLE MARK	
OSD LANG	ENGLISH
CAPTIONS	
SCR SAVER	
MAIN PAGE	

OSD LANG type setup

Select the preferred OSD language by using the ▲/▼ buttons.

-- GENERAL PAGE --

TV DISPLAY	
PIC MODE	
ANGLE MARK	ON
OSD LANG	OFF
CAPTIONS	
SCR SAVER	
MAIN PAGE	

ANGLE MARK display setup

If it is set to ON, when the multi-angle DVD disc is playing, “∞” (the angle mark) will appears on the screen; if is set to “OFF”, the mark will not appear.

-- GENERAL PAGE --

TV DISPLAY	
PIC MODE	
ANGLE MARK	
OSD LANG	
CAPTIONS	ON
SCR SAVER	OFF
MAIN PAGE	

CAPTIONS setup

Activate the CAPTIONS feature by selecting ON. And release this feature by selecting OFF.

SETUP

-- GENERAL PAGE --

TY DISPLAY	
PIC MODE	
ANGLE MARK	
OSD LANG	
CAPTIONS	
SCR SAVER	ON
	OFF
MAIN PAGE	

SCR SAVER setup

Select the SCR SAVER output ON/OFF.

SPEAKER SETUP

-- SPEAKER SETUP PAGE --

DOWNMIX	LT/RT
	STEREO
MAIN PAGE	

This is to activate the audio output from DOLBY AC3 5.1 DOWNMIX to 2 channel mode.

Select the preferred SPEAKER connection by using the cursor buttons.

- ➔ Select the LT/RT to activate the Dolby surround compatible output.
- ➔ Select the STEREO to activate simple stereo mode.

AUDIO SETUP

-- AUDIO SETUP --

AUDIO OUT	ANALOG
OP MODE	SPDIF/RAW
DYNAMIC	SPDIF/PCM
LPCM OUTPUT	
MAIN PAGE	

AUDIO OUT

This is to activate the audio output from ANALOG mode to SPDIF/RAW mode to SPDIF/PCM mode.

-- AUDIO SETUP --

AUDIO OUT	
OP MODE	LINE OUT
DYNAMIC	RF REMOD
LPCM OUTPUT	
MAIN PAGE	

OP MODE

There are two operating modes for the Dolby Digital decoder: LINE OUT and RF REMOD.

SETUP

-- AUDIO SETUP --

AUDIO OUT
OP MODE
DYNAMIC
LPCM OUTPUT

FULL
6/8
4/8
2/8
OFF

MAIN PAGE

Dynamic range Control

Select DYNAMIC and adjust the dynamic range of a Dolby Digital encoded program. There are 8 steps between full compression and off compression.

PREFERENCES SETUP

--PREFERENCES PAGE--

TV TYPE	AUTO
AUDIO	NTSC
SUBTITLE	PAL
DISC MENU	
PARENTAL	
PASSWORD	
DEFAULTS	
SMART NAV	
MAIN PAGE	

TV type setup

This player can play discs recorded in either PAL or NTSC format. Select NTSC format, when you connected to NTSC TV. Select PAL format, when you connected to PAL TV. Select AUTO format, the player TV output format will accord the DVD disc format.

-- AUDIO SETUP --

AUDIO OUT
OP MODE
DYNAMIC
LPCM OUTPUT
LPCM 48K
LPCM 96K

MAIN PAGE

LPCM OUTPUT

Select the LPCM OUTPUT between LPCM48K and LPCM 96K.

--PREFERENCES PAGE--

TV TYPE	
AUDIO	ENGLISH
SUBTITLE	FRENCH
DISC MENU	SPANISH
PARENTAL	CHINESE
PASSWORD	JAPANESE
DEFAULTS	
SMART NAV	
MAIN PAGE	

AUDIO language setup

Select the preferred AUDIO soundtrack by using the cursor buttons.

SETUP

--PREFERENCES PAGE--

TV TYPE	
AUDIO	
SUBTITLE	ENGLISH
DISC MENU	FRENCH
PARENTAL	SPANISH
PASSWORD	CHINESE
DEFAULTS	JAPANESE
SMART NAV	OFF
MAIN PAGE	

SUBTITLE language setup

Select the preferred SUBTITLE language by using the cursor buttons.

-- PREFERENCES PAGE --

TV TYPE	1 G
AUDIO	2
SUBTITLE	3 PG
DISC MENU	4 PG 13
PARENTAL	5
PASSWORD	6 PG-R
DEFAULTS	7 NC-17
SMART NAV	8 ADULT
MAIN PAGE	NO_PARENTAL

PARENTAL

Select suitable parental guidance by the cursor buttons and conformed by pressing ENTER button.

--PREFERENCES PAGE--

TV TYPE	
AUDIO	
SUBTITLE	
DISC MENU	ENGLISH
PARENTAL	FRENCH
PASSWORD	SPANISH
DEFAULTS	CHINESE
SMART NAV	JAPANESE
MAIN PAGE	

DISC MENU language setup

Select the preferred DISC MENU language by using the cursor buttons.

-- PREFERENCES PAGE --

TV TYPE	
AUDIO	
SUBTITLE	
DISC MENU	
PARENTAL	
PASSWORD	CHANGE
DEFAULTS	
SMART NAV	
MAIN PAGE	

PASSWORD

Select CHANGE and press ENTER button. Type the old password (The initial factory code is 3308) and key in 4 characters password now you want to use, and retype again to confirm key in correctly.

SETUP

-- PREFERENCES PAGE --

TV TYPE	
AUDIO	
SUBTITLE	
DISC MENU	
PARENTAL	
PASSWORD	
DEFAULTS	RESET
SMART NAV	
MAIN PAGE	

DEFAULTS

Select reset to become factory initial setting.

DEFAULTS TABLE

General Setup	TV display	Normal/LB
	PIC mode	AUTO
	Angle mark	ON
	OSD Language	English
	Captions	ON
	SCR Saver	ON
Speaker Setup	Downmix	Stereo
Audio Setup	Audio Out	SPDIF/RAW
	OP Mode	Line Out
	Dynamic	FULL
	LPCM Output	LPCM 96K
Preferences	TV Type	AUTO
	Audio	English
	Subtitle	English
	DISC menu	English
	Parental	NO_Parental
	Password	3308
	Smart NAV	With Menu

-- PREFERENCES PAGE --

TV TYPE	
AUDIO	
SUBTITLE	
DISC MENU	
PARENTAL	
PASSWORD	
DEFAULTS	NO MENU
SMART NAV	WITH MENU
MAIN PAGE	

SMART NAV

In this item, you can select NO MENU mode or WITH MENU mode.

SPECIFICATIONS

Supply voltage:	2V DC (11V-15V), test voltage 14.4V, negative ground
Current consumption:	Less than 2A
Signal system:	Compositive video 1.0Vp-p 75Ω
Discs played:	(1) DVD-VIDEO disc 5"(12 cm) single-sided, single-layer 5"(12 cm) single-sided, double-layer (2) Compact disc (CD-DA) 5"(12 cm) disc
Audio output level:	600Ω (2 ch 2.0 Vrms)
Audio signal output characteristics:	(1) Frequency response: 20 Hz-20 kHz (2) S/N ratio: 80 dB (JIS) (3) Wow and Flutter Below measurable limits

Note:

Specifications and design are subject to modification, without notice, due to improvements in technology.

This product incorporates copyright protection technology that is protected by method claims of certain U.S. patents and other intellectual property rights owned by Macrovision Corporation and other rights owners. Use of this copyright protection technology must be authorized by Macrovision Corporation, and is intended for home and other limited viewing uses only unless otherwise authorized by Macrovision Corporation. Reverse engineering or disassembly is prohibited.